

## GEBRAUCHSANLEITUNG

D

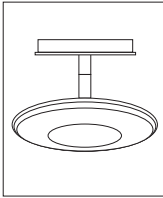

### EUCLID SPOT 80° ALL-IN

ART.-NO. 714010

#### TECHNISCHE DATEN

Spannung: 230 VAC  
Leistung: 10W  
Farbtemperatur: 714010 2700K  
714010-x3x 3000K

Schutzklasse:



Dimmbar:

<http://www.bruck.de/de/faq/dimmer-empfehlung/>



### ALLGEMEINE SICHERHEITSHINWEISE



- Bei allen durchzuführenden Arbeiten an den Produkten (Montage, Wartung, Reinigung) Spannungsversorgung abschalten.
- Die Produkte sind nur für IP 20 Bereiche zugelassen.
- Vorsicht! Produkte (auch LED) können im Betrieb heiß werden.
- Den angegebenen Mindestabstand der Lichtquelle zu brennbaren Gegenständen beachten\*
- Wir behalten uns vor, jederzeit Änderungen an den Produkten vorzunehmen! Aktuelle Daten finden sie jederzeit unter [www.bruck.de](http://www.bruck.de).
- Bei eigenmächtigen Veränderungen oder unsachgemäßer Benutzung erlischt jeglicher Anspruch auf Gewährleistung.



LIEFERUMFANG  
1 LEUCHE KOMPLETT



MONTAGE: VORBEREITUNG RICHTIG / MOUNTING: PREPARATION CORRECT / MONTAGE: PRÉPARATION CORRECTE  
MONTAJE: PREPARAZIONE CORRECTO / MONTAGGIO: PREPARACIÓN CORRECTO

VOLLSTÄNDIG  
COMPLETE  
COMPLET  
COMPLETO  
COMPLETO

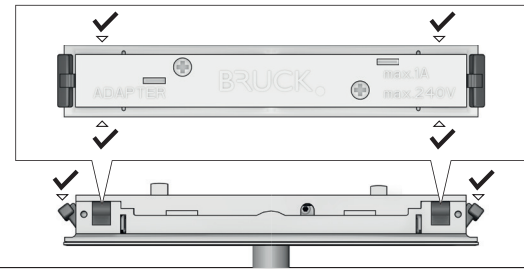

VOLLSTÄNDIG  
COMPLETE  
COMPLET  
COMPLETO  
COMPLETO



MONTAGE: VORBEREITUNG FALSCH / MOUNTING: PREPARATION WRONG / MONTAGE: PRÉPARATION INCORRECTE / MONTAJE: PREPARAZIONE INCORRECTO / MONTAGGIO: PREPARACIÓN INCORRECTO



UNVOLLSTÄNDIG  
INCOMPLETE  
INCOMPLET  
INCOMPLETO  
INCOMPLETO

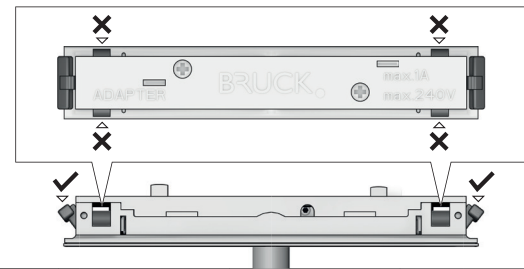

UNVOLLSTÄNDIG  
INCOMPLETE  
INCOMPLET  
INCOMPLETO  
INCOMPLETO

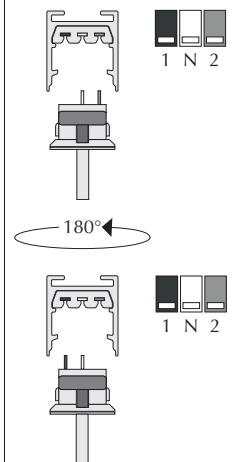
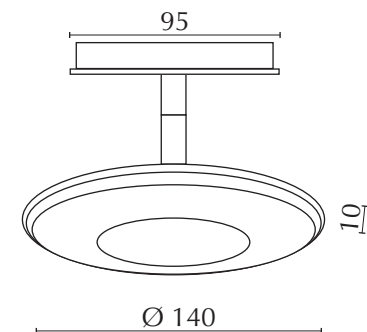
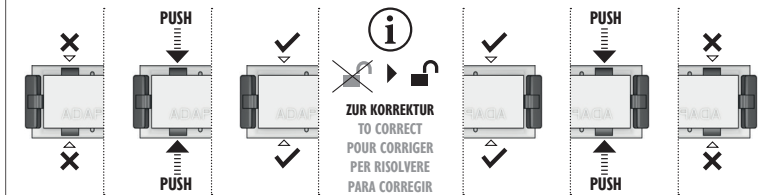

1 N 2

1 N 2

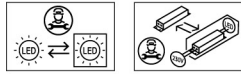

## INSTRUCTION MANUAL

GB

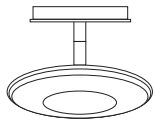

## EUCLID SPOT 80° ALL-IN

ART.-NO. 714010

## TECHNICAL DATA

Voltage: 230 VAC  
 Wattage: 10W  
 Colour temperature: 714010 2700K  
 714010-x3x 3000K

Protection class:



Dimmable:  
[bruck.co.uk/en/faq/dimmer-recommendation/](http://bruck.co.uk/en/faq/dimmer-recommendation/)



## GENERAL REMARKS ON SAFETY



- For all work to be carried out on the products (assembly, maintenance, repair, cleaning, etc.) switch off the power supply.
- The products are only approved for IP 20 areas.
- Caution! Products (also LED) can become hot during operation.
- Observe the specified minimum distance of the light source to flammable objects \*
- We reserve the right to make changes to the products at any time! Current data can be found at [www.bruck.de](http://www.bruck.de).
- With arbitrary changes or improper use any warranty claim expires.



DELIVERY SCOPE:  
 1 LUMINAIRE COMPLETE



## MODE D'EMPLOI

F

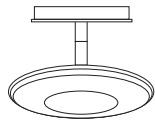

## EUCLID SPOT 80° ALL-IN

REF. 714010

## CARACTERISTIQUES TECHNIQUES

Voltage: 230 VAC  
 Puissance: 10W  
 Température de couleur: 714010 2700K  
 714010-x3x 3000K

Classe de protection:



Gradable:  
[bruckclairage.fr/fr/faq/recommandation-du-gradateur/](http://bruckclairage.fr/fr/faq/recommandation-du-gradateur/)



## CONSIGNES DE SECURITE GENERALES



- Pour tous les travaux à effectuer sur les produits (montage, entretien, réparation, nettoyage, etc.) il faut couper l'alimentation électrique.
- Les produits ne sont homologués que pour les zones IP 20.
- Attention! Les produits (également LED) peuvent devenir chauds pendant le fonctionnement.
- Respecter la distance minimale spécifiée entre la source lumineuse et les objets inflammables \*
- Nous nous réservons le droit d'apporter des modifications aux produits à tout moment! Les données actuelles peuvent être consultées à tout moment sur [www.bruck.de](http://www.bruck.de).
- En cas de modifications arbitraires ou d'utilisation incorrecte, la garantie expire.



VOLUME DE LIVRAISON:  
 1 LUMINAIRE COMPLÈTE



## INSTRUCCIONES DE EMPLEO

E

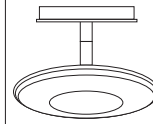

## EUCLID SPOT 80° ALL-IN

REF. 714010

## DATOS TECNICOS

Voltaje: 230 VAC  
 Potencia: 10W  
 Temperatura de color: 714010 2700K  
 714010-x3x 3000K

Clase de protección:



Regulable:  
[bruck.com.es/es/faq/recomendacion-de-atenuacion/](http://bruck.com.es/es/faq/recomendacion-de-atenuacion/)



## INDICACIONES GENERALES DE SEGURIDAD



- Para todos los trabajos a realizar en los productos (montaje, mantenimiento, reparación, limpieza, etc.) hay que desconectar la alimentación eléctrica.
- Los productos sólo están aprobados para áreas IP 20.
- Precaución! Los productos (también LED) pueden calentarse durante el funcionamiento.
- Observar la distancia mínima especificada entre la fuente de luz y los objetos inflamables \*
- Nos reservamos el derecho de hacer cambios en los productos en cualquier momento! Los datos actuales se pueden encontrar en [www.bruck.de](http://www.bruck.de).
- Con cambios arbitrarios o uso indebido caduca cualquier reclamo de garantía.



VOLUMEN DE ENTREGA:  
 1 LAMPARA COMPLETA



## ISTRUZIONI PER L'USO

I

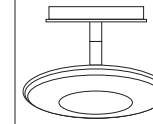

## EUCLID SPOT 80° ALL-IN

COD. 714010

## DATI TECNICI

Tensione: 230 VAC  
 Wattaggio: 10W  
 Temperatura colore: 714010 2700K  
 714010-x3x 3000K

Tipo di protezione:



Dimmerabile:  
[bruck.co.it/it/faq/raccomandazione-varialuce/](http://bruck.co.it/it/faq/raccomandazione-varialuce/)



## AVVERTENZE GENERALI PER LA SICUREZZA



- Per tutti i lavori da eseguire sui prodotti (montaggio, manutenzione, riparazione, pulizia ecc.) spegnere l'alimentazione elettrica.
- I prodotti sono approvati solo per ambienti IP 20.
- Attenzione! I prodotti (anche i LED) possono riscaldarsi in funzione.
- Rispettare la distanza minima specificata della sorgente luminosa dagli oggetti che sono infiammabili \*
- Ci riserviamo il diritto di apportare modifiche ai prodotti in qualsiasi momento! I dati attuali possono essere trovati in qualsiasi momento all'indirizzo [www.bruck.de](http://www.bruck.de).
- In caso di modifiche non autorizzate o di uso improprio, tutti i diritti di garanzia scadano.



VOLUME DELLA FORNITURA:  
 1 LAMPADA COMPLETA



ADAPTER MONTIEREN / ASSEMBLING THE ADAPTER THE ADAPTER / MONTAGE DE L'ADAPTATEUR  
 MONTAJE DEL ADAPTADOR / MONTARE L'ADATTATORE

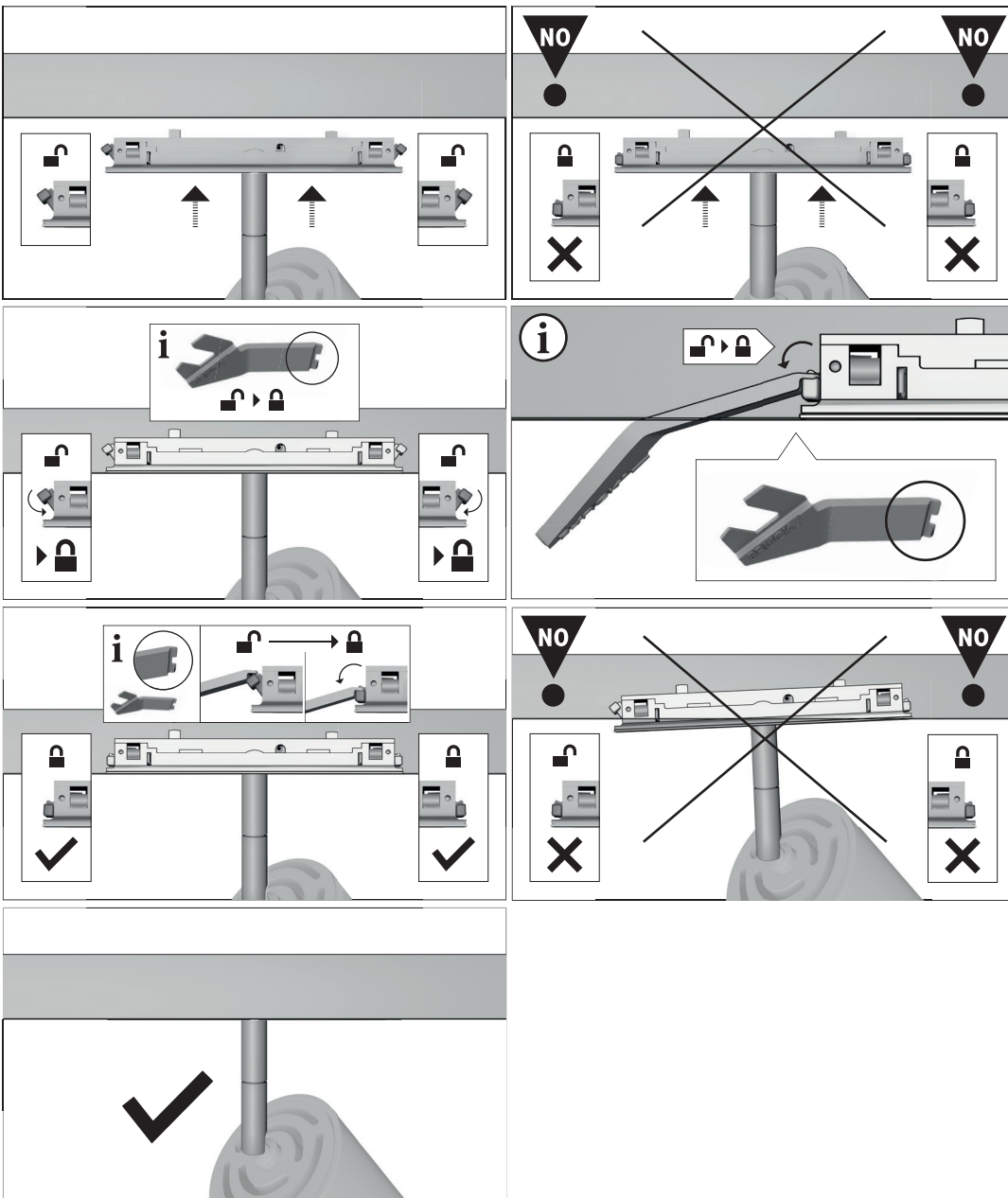

ADAPTER ABMONTIEREN / DISASSEMBLING THE ADAPTER / DEMONTAGE DE L'ADAPTATEUR  
 DESMONTAJE DEL ADAPTADOR / RIMUOVERE L'ADATTATORE

