

GEBRAUCHSANLEITUNG

D

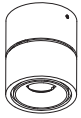

VITO 75 SPOT 50° LV C

ART.-NO. 101307

TECHNISCHE DATEN

Spannung: 230 VAC
Leistung: 9W
Farbtemperatur: 2000-3000K

Schutzklasse:



Dimmung:



Dimmbar:
bruck.de/de/faq/bruck



ALLGEMEINE SICHERHEITSHINWEISE



1. Montage und Inbetriebnahme der Produkte nur durch autorisiertes Fachpersonal unter Berücksichtigung dieser Montageanleitung, Sicherheitshinweisen und aller für den Anwendungsbereich geltenden Normen und Vorschriften durchführen!
2. Bei allen durchzuführenden Arbeiten an den Produkten (Montage, Wartung, Reinigung) Spannungsversorgung abschalten.
3. Die Produkte sind nur für IP 20 Bereiche zugelassen.
4. Vorsicht! Produkte (auch LED) können im Betrieb heiß werden.
5. Den angegebenen Mindestabstand der Lichtquelle zu brennbaren Gegenständen beachten.*
6. Wir behalten uns vor, jederzeit Änderungen an den Produkten vorzunehmen! Aktuelle Daten finden sie jederzeit unter www.bruck.de.
7. Bei eigenmächtigen Veränderungen oder unsachgemäßer Benutzung erlischt jeglicher Anspruch auf Gewährleistung.



LIEFERUMFANG
1 LEUCHE KOMPLETT

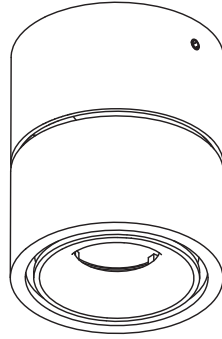

1.

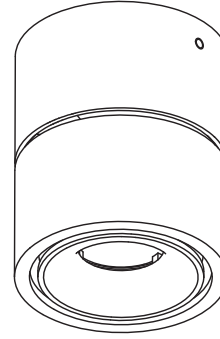

2.

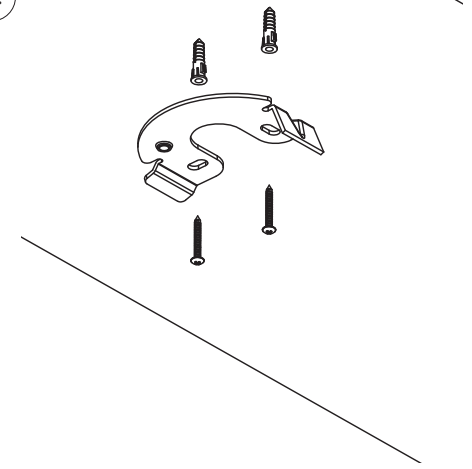

3.

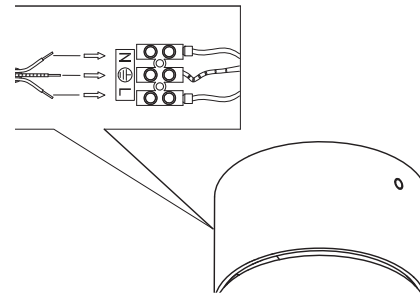

4.

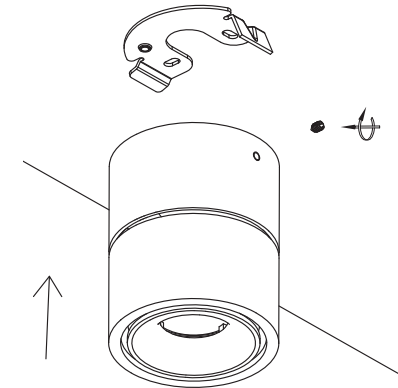

5.a

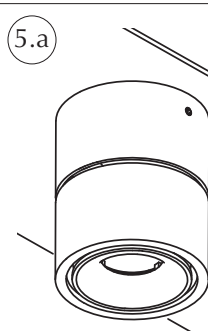

5.b

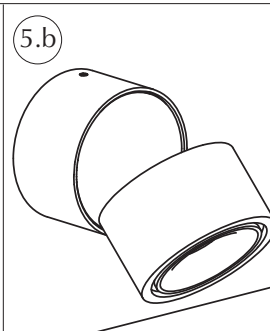

92

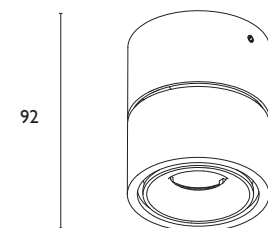

Ø75

90°

350°

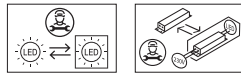

INSTRUCTION MANUAL

GB

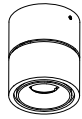

VITO 75 SPOT 50° LV C

ART.-NO. 101307

TECHNICAL DATA

Voltage: 230 VAC
 Wattage: 9W
 Colour temperature: 2000-3000K

Protection class:

Dimmable using:

Dimmable:
bruck.co.uk/en/faq/dimmer-recommendation/



GENERAL REMARKS ON SAFETY



1. Assembly and commissioning of the products only by authorized specialist personnel, observing these assembly instructions, safety instructions and all regulations applicable to the area of application. Carry out standards and regulations!
2. For all work to be carried out on the products (assembly, maintenance, repair, cleaning, etc.) switch off the power supply.
3. The products are only approved for IP 20 areas.
4. Caution! Products (also LED) can become hot during operation.
5. Observe the specified minimum distance of the light source to flammable objects. *
6. We reserve the right to make changes to the products at any time! Current data can be found at www.bruck.de.
7. With arbitrary changes or improper use any warranty claim expires.



DELIVERY SCOPE:
 1 LUMINAIRE COMPLETE



MODE D'EMPLOI

F



VITO 75 SPOT 50° LV C

REF. 101307

CARACTERISTIQUES TECHNIQUES

Voltage: 230 VAC
 Puissance: 9W
 Température de couleur: 2000-3000K

Classe de protection:

Compatible avec les variateurs:

Gradable:
bruckclairage.fr/fr/faq/recommandation-du-gradateur/



CONSIGNES DE SECURITE GENERALES



1. Le montage et la mise en service des produits ne doivent être effectués que par du personnel spécialisé autorisé, en respectant les présentes instructions de montage, les consignes de sécurité et toutes les réglementations en vigueur dans le domaine d'application. Respecter les normes et réglementations !
2. Pour tous les travaux à effectuer sur les produits (montage, entretien, réparation, nettoyage, etc.) il faut couper l'alimentation électrique.
3. Les produits ne sont homologués que pour les zones IP 20.
4. Attention! Les produits (également LED) peuvent devenir chauds pendant le fonctionnement.
5. Respecter la distance minimale spécifiée entre la source lumineuse et les objets inflammables. *
6. Nous nous réservons le droit d'apporter des modifications aux produits à tout moment ! Les données actuelles peuvent être consultées à tout moment sur www.bruck.de.
7. En cas de modifications arbitraires ou d'utilisation incorrecte, la garantie expire.



VOLUME DE LIVRAISON:
 1 LUMINAIRE COMPLÈTE



INSTRUCCIONES DE EMPLEO

E



VITO 75 SPOT 50° LV C

REF. 101307

DATOS TECNICOS

Voltaje: 230 VAC
 Potencia: 9W
 Temperatura de color: 2000-3000K

Clase de protección:

Atenuable mediante:

Regulable:
bruck.com.es/es/faq/recomendacion-de-atenuacion/



INDICACIONES GENERALES DE SEGURIDAD



1. El montaje y la puesta en marcha de los productos deben ser realizados exclusivamente por personal técnico autorizado, respetando estas instrucciones de montaje, las instrucciones de seguridad y todas las normas aplicables en el área de aplicación. Cumplir con las normas y reglamentos!
2. Para todos los trabajos a realizar en los productos (montaje, mantenimiento, reparación, limpieza, etc.) hay que desconectar la alimentación eléctrica.
3. Los productos sólo están aprobados para áreas IP 20.
4. Precaución! Los productos (también LED) pueden calentarse durante el funcionamiento.
5. Observar la distancia mínima especificada entre la fuente de luz y los objetos inflamables. *
6. Nos reservamos el derecho de hacer cambios en los productos en cualquier momento! Los datos actuales se pueden encontrar en www.bruck.de.
7. Con cambios arbitrarios o uso indebido caduca cualquier reclamo de garantía.



VOLUMEN DE ENTREGA:
 1 LAMPARA COMPLETA



ISTRUZIONI PER L'USO

I



VITO 75 SPOT 50° LV C

COD. 101307

DATI TECNICI

Tensione: 230 VAC
 Wattaggio: 9W
 Temperatura colore: 2000-3000K

Tipo di protezione:

Regolabile mediante:

Dimmerabile:
bruck.co.it/it/faq/raccomandazione-varialuce/



AVVERTENZE GENERALI PER LA SICUREZZA



1. Montaggio e collegamento della lampada soltanto esclusivamente da personale specializzato autorizzato, nel rispetto delle presenti istruzioni di montaggio, delle istruzioni di sicurezza e di tutte le norme applicabili al campo di applicazione. Eseguire le norme e i regolamenti!
2. Per tutti i lavori da eseguire sui prodotti (montaggio, manutenzione, riparazione, pulizia ecc.) spegnere l'alimentazione elettrica.
3. I prodotti sono approvati solo per ambienti IP 20.
4. Attenzione! I prodotti (anche i LED) possono riscaldarsi in funzione.
5. Rispettare la distanza minima specificata della sorgente luminosa dagli oggetti che sono infiammabili. *
6. Ci riserviamo il diritto di apportare modifiche ai prodotti in qualsiasi momento! I dati attuali possono essere trovati in qualsiasi momento all'indirizzo www.bruck.de.
7. In caso di modifiche non autorizzate o di uso improprio, tutti i diritti di garanzia scadano.



VOLUME DELLA FORNITURA:
 1 LAMPADA COMPLETA

