

# BLOP pendant lights

BLOP 60° ALL-IN

714051sw

LED

Dimmable

€419.00

detail.deliveryTimeAvailable2

## Body Color

painted black

## Systems

ALL-IN 230V track

## Angle

60°

## Bulb Type

AC-LED

## Light Color

2.700K

## Technical specifications

### Body color

painted black

### Primary connection voltage

230 Volt

### Dimmable

Phasenabschnitt (C)

### Input power

12 Watt

### Light color

2700 K

### Option

Optional 3000k

### LED luminous flux

950 lm

### Color rendering index

CRI 90

### Safety class

2

### Ingress protection

IP20

### Weight

0.46 kg

### Design

Dirk Wortmeyer

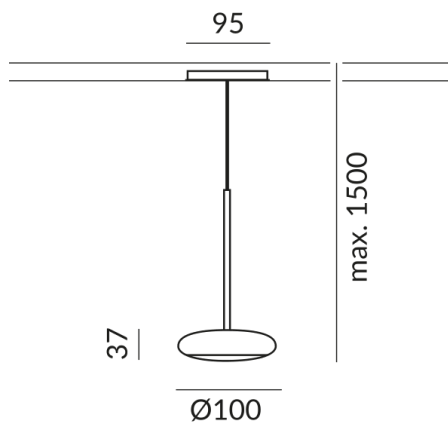



### Information on operating LED lights

Thank you for choosing our LED lights.

To ensure the best possible performance and longevity of your new lighting, please observe the following instructions:

1. When operating LED lights, visible, brief changes in light may occur due to voltage changes in the mains. This does not constitute a defect in the light.
2. For dimming LED lights. Not all LED lamps are compatible with all dimmers. Please check compatibility before installation. Incompatibility does not constitute a defect in the luminaire.
3. Flickering at low dimmer settings (from 50%): When using dimmers, slight flickering may occur at low settings. This is normal behaviour and does not constitute a defect in the luminaire.

---

**BRUCK GmbH & Co. KG**  
Industriestr. 22a  
44628 Herne

Tel: +49 (0)2323 - 5910  
E-Mail: [sales@bruck.de](mailto:sales@bruck.de)

<https://bruck.de>