

BLOP spotlights



BLOP SPOT 30° MICRO, 10W, 24Vdc, PC3, 2700K

616080hb
LED
Dimmable
€429.00

Available, delivery time: 7 days

Body Color

champagner, adapter black

Mount Type

Deckenanbau (C)

Angle

30°

Systems

MICRO 24V track

Bulb Type

LV-LED

Light Color

2.700K

Assortment Status

Catalog item

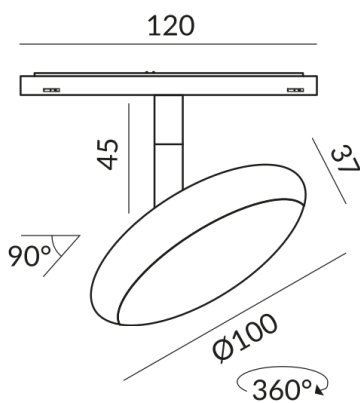

Technical specifications

Body color

champagner, adapter black

Primary connection voltage

24 Volt

Dimmable

Bluetooth-Funk Dimmung

Input power

10 Watt

Light color

2700 K

Option

Optional 3000k

LED luminous flux

1000 lm

Color rendering index

CRI 90

Safety class

3

Ingress protection

IP20

Weight

0.41 kg

Design

Dirk Wortmeyer

Information on operating LED lights

Thank you for choosing our LED lights.

To ensure the best possible performance and longevity of your new lighting, please observe the following instructions:

1. When operating LED lights, visible, brief changes in light may occur due to voltage changes in the mains. This does not constitute a defect in the light.
2. For dimming LED lights. Not all LED lamps are compatible with all dimmers. Please check compatibility before installation. Incompatibility does not constitute a defect in the luminaire.
3. Flickering at low dimmer settings (from 50%): When using dimmers, slight flickering may occur at low settings. This is normal behaviour and does not constitute a defect in the luminaire.

BRUCK GmbH & Co. KG
Industriestr. 22a
44628 Herne

Tel: +49 (0)2323 - 5910
E-Mail: sales@bruck.de

<https://bruck.de>