



KLYP Pendant lights

KLYP 60° AC OE, 10W, PC2, 2700K

135026mcgy

LED

Dimmable

€279.00

Available, delivery time: 7 days

Systems

AC pendant for canopy system

Bulb Type

AC-LED

Body Color

matt chrome-plated / painted

Angle

60°

Light Color

2.700K

Technical specifications

Body color

matt chrome-plated / painted

Primary connection voltage

230 Volt

Dimmable

Phasenabschnitt (C)

Input power

10 Watt

Light color

2700 K

Option

Optional 3000k

LED luminous flux

800 lm

Color rendering index

CRI 90

Safety class

2

Ingress protection

IP20

Weight

0.44 kg

Design

BRUCK-Design

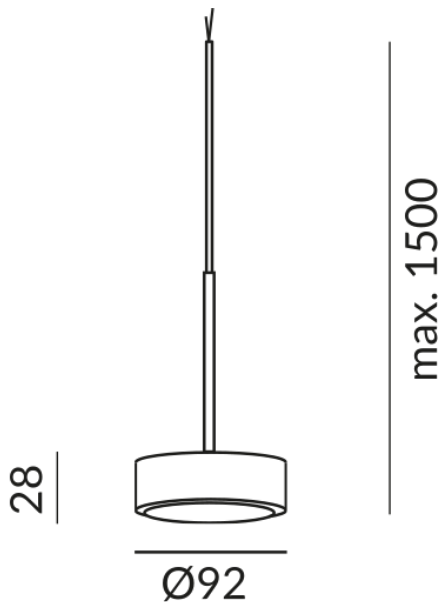

Information on operating LED lights

Thank you for choosing our LED lights.

To ensure the best possible performance and longevity of your new lighting, please observe the following instructions:

1. When operating LED lights, visible, brief changes in light may occur due to voltage changes in the mains. This does not constitute a defect in the light.
2. For dimming LED lights. Not all LED lamps are compatible with all dimmers. Please check compatibility before installation. Incompatibility does not constitute a defect in the luminaire.
3. Flickering at low dimmer settings (from 50%): When using dimmers, slight flickering may occur at low settings. This is normal behaviour and does not constitute a defect in the luminaire.

BRUCK GmbH & Co. KG
Industriestr. 22a
44628 Herne

Tel: +49 (0)2323 - 5910
E-Mail: sales@bruck.de

<https://bruck.de>